

**PCB Connector Series**

KLS1-540B Pitch=2.0mm TYPE

**Electrical Specification:**

Current Rating: 2 AMP  
 Insulator Resistance: 1000M Ohm min. at DC 500V  
 Contact Resistance: 20m Ohm max. at DC 100mA  
 Withstand voltage: 1000V AC/min  
 Operating Temperature: -55°C~+105°C

**Material:**

Housing: Nylon 66 UL94V-0  
 Contacts: Phosphor Bronze  
 Plating: Tin 50u" over 100u" nickel



Housing 540B

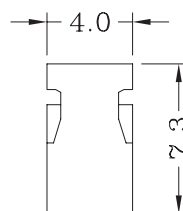
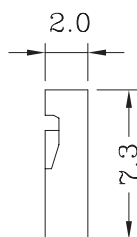
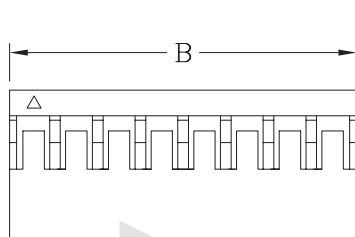
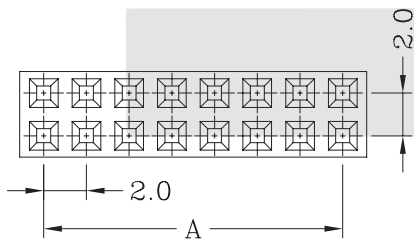
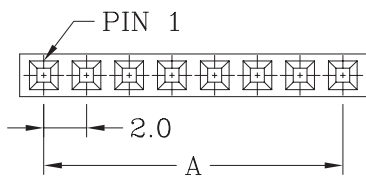

Part No	Dimensions		Part No	Dimensions	
	A	B		A	B
1x2P	2.00	4.25	2x2P	2.00	4.25
1x3P	4.00	6.25	2x3P	4.00	6.25
1x4P	6.00	8.25	2x4P	6.00	8.25
1x5P	8.00	10.25	2x5P	8.00	10.25
1x6P	10.00	12.25	2x6P	10.00	12.25
1x7P	12.00	14.25	2x7P	12.00	14.25
1x8P	14.00	16.25	2x8P	14.00	16.25
1x9P	16.00	18.25	2x9P	16.00	18.25
1x10P	18.00	20.25	2x10P	18.00	20.25
1x11P	20.00	22.25	2x11P	20.00	22.25
1x12P	22.00	24.25	2x12P	22.00	24.25
1x13P	24.00	26.25	2x13P	24.00	26.25
1x14P	26.00	28.25	2x14P	26.00	28.25
1x15P	28.00	30.25	2x15P	28.00	30.25
1x16P	30.00	32.25	2x16P	30.00	32.25
1x17P	32.00	34.25	2x17P	32.00	34.25
1x18P	34.00	36.25	2x18P	34.00	36.25
1x19P	36.00	38.25	2x19P	36.00	38.25
1x20P	38.00	40.25	2x20P	38.00	40.25
1x21P	40.00	42.25	2x21P	40.00	42.25
1x22P	42.00	44.25	2x22P	42.00	44.25
1x23P	44.00	46.25	2x23P	44.00	46.25
1x24P	46.00	48.25	2x24P	46.00	48.25
1x25P	48.00	50.25	2x25P	48.00	50.25
1x26P	50.00	52.25			
1x27P	52.00	54.25			
1x28P	54.00	56.25			
1x29P	56.00	58.25			
1x30P	58.00	60.25			
1x31P	60.00	62.25			
1x32P	62.00	64.25			
1x33P	64.00	66.25			
1x34P	66.00	68.25			
1x35P	68.00	70.25			
1x36P	70.00	72.25			
1x37P	72.00	74.25			
1x38P	74.00	76.25			
1x39P	76.00	78.25			
1x40P	78.00	80.25			

**ORDER INFORMATION**

Product NO.: KLS1-540 B-1X02-H

Series No. \_\_\_\_\_ Type: H-Housing T-Terminal  
 Pitch: A=2.54mm B=2.00mm PIN Number:02 ~ 25Pin  
 Pins: 1-Single layer 2-Double layer

## Wire To Board Connectors

KLS1-540B Pitch=2.0mm TYPE, Terminal

### Electrical Specification:

Current Rating: 2.0A AC DC  
 Current Voltage: 250V AC DC  
 Insulator Resistance:  $\geq 1000m \text{ Ohm}$   
 Contact Resistance:  $\leq 20m \text{ Ohm}$   
 Withstand voltage: 1000V AC/MIN  
 Applicable wire: AWG #30~#26  
 Operating Temperature:  $-25^{\circ}\text{C} \sim +85^{\circ}\text{C}$

### Material:

Terminal: Phosphor Bronze, tin-plating

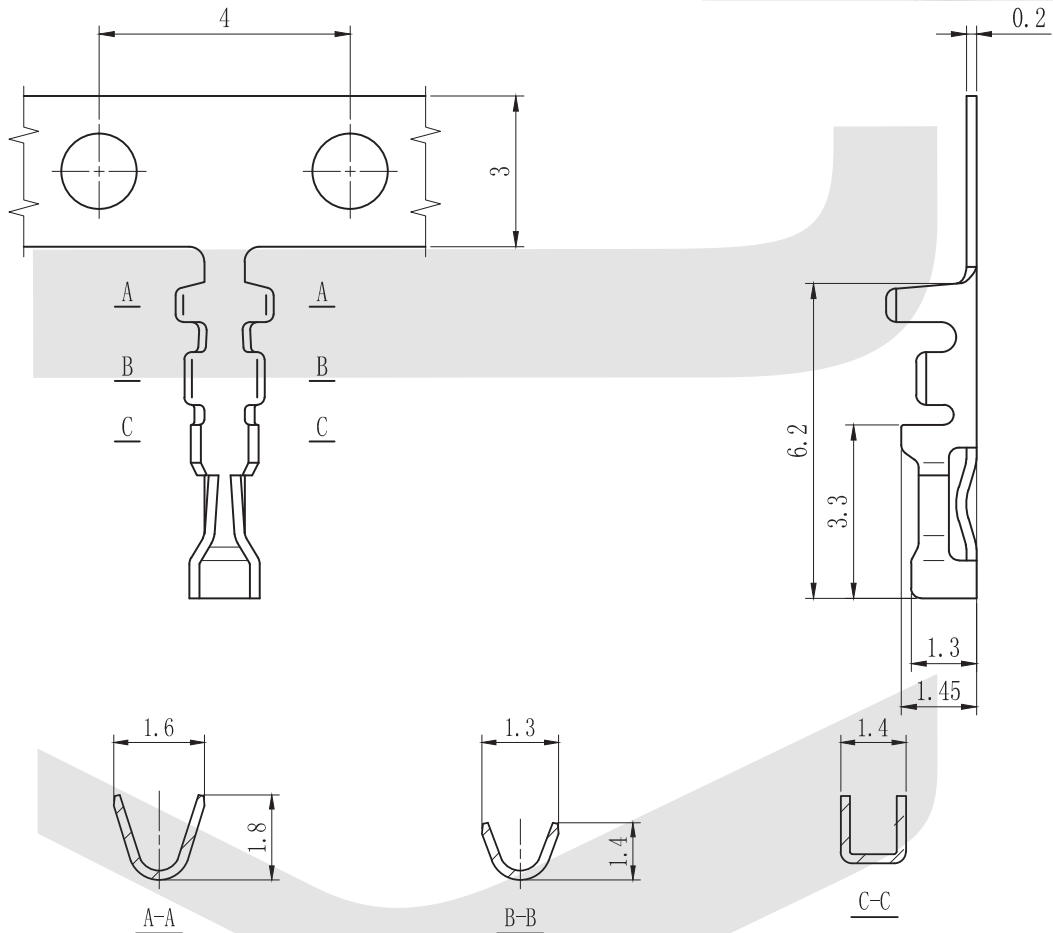

## ORDER INFORMATION

Product NO.: KLS1-540-B-T

Series No. \_\_\_\_\_

Pitch: \_\_\_\_\_  
 A=2.54mm  
 B=2.00mm

Type:  
 H-Housing  
 T-Terminal

**PCB Connector Series**

**KLS1-540A Pitch=2.54mm TYPE**

**Electrical Specification:**

Current Rating: 3 AMP  
 Insulator Resistance: 5000M Ohm min. at DC 500V  
 Contact Resistance: 20m Ohm max. at DC 100mA  
 Withstand voltage: 800V AC/MIN  
 Operating Temperature: -55°C~+105°C

**Material:**

Housing: Nylon 66 UL94V-0  
 Contacts: Phosphor Bronze  
 Plating: Tin 50u" over 100u" nickel



**Housing 540A**

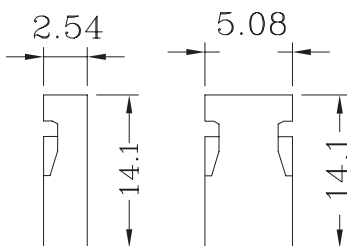
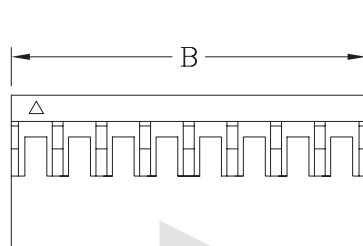
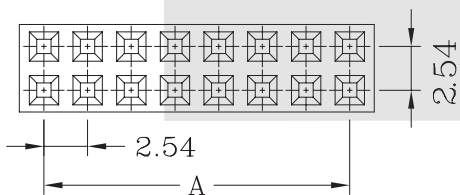
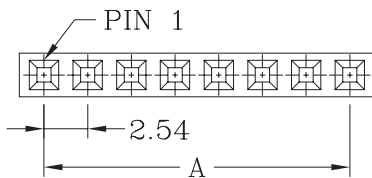

Part No	Dimensions		Part No	Dimensions	
	A	B		A	B
1x 2P	2.54	5.08	2x 2P	2.54	5.08
1x 3P	5.08	7.62	2x 3P	5.08	7.62
1x 4P	7.62	10.16	2x 4P	7.62	10.16
1x 5P	10.16	12.70	2x 5P	10.16	12.70
1x 6P	12.70	15.24	2x 6P	12.70	15.24
1x 7P	15.24	17.78	2x 7P	15.24	17.78
1x 8P	17.78	20.32	2x 8P	17.78	20.32
1x 9P	20.32	22.86	2x 9P	20.32	22.86
1x 10P	22.86	25.40	2x 10P	22.86	25.40
1x 11P	25.40	27.94	2x 11P	25.40	27.94
1x 12P	27.94	30.48	2x 12P	27.94	30.48
1x 13P	30.48	33.02	2x 13P	30.48	33.02
1x 14P	33.02	35.56	2x 14P	33.02	35.56
1x 15P	35.56	38.10	2x 15P	35.56	38.10
1x 16P	38.10	40.64	2x 16P	38.10	40.64
1x 17P	40.64	43.18	2x 17P	40.64	43.18
1x 18P	43.18	45.72	2x 18P	43.18	45.72
1x 19P	45.72	48.26	2x 19P	45.72	48.26
1x 20P	48.26	50.80	2x 20P	48.26	50.80
1x 21P	50.80	53.34	2x 21P	50.80	53.34
1x 22P	53.34	55.88	2x 22P	53.34	55.88
1x 23P	55.88	58.42	2x 23P	55.88	58.42
1x 24P	58.42	60.96	2x 24P	58.42	60.96
1x 25P	60.96	63.50	2x 25P	60.96	63.50

**ORDER INFORMATION**

Product NO.: **KLS1-540 A-1X02-H**

Series No. \_\_\_\_\_ Type: H-Housing T-Terminal  
 Pitch: A=2.54mm \_\_\_\_\_ PIN Number: 02 ~ 25Pin  
 B=2.00mm \_\_\_\_\_ Pins: 1-Single layer  
 2-Double layer

**PCB Connector Series**

KLS1-540A Pitch=2.54mm TYPE

**Electrical Specification:**

Current Rating: 3 AMP  
Insulator Resistance: 5000M Ohm min. at DC 500V  
Contact Resistance: 20m Ohm max. at DC 100mA  
Withstand voltage: 800V AC/MIN  
Operating Temperature: -55°C~+105°C

**Material:**

Housing: Nylon 66 UL94V-0  
Contacts: Phosphor Bronze  
Plating: Tin 50u" over 100u" nickel



**Terminal 540A**

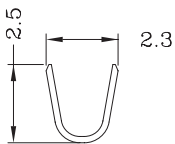
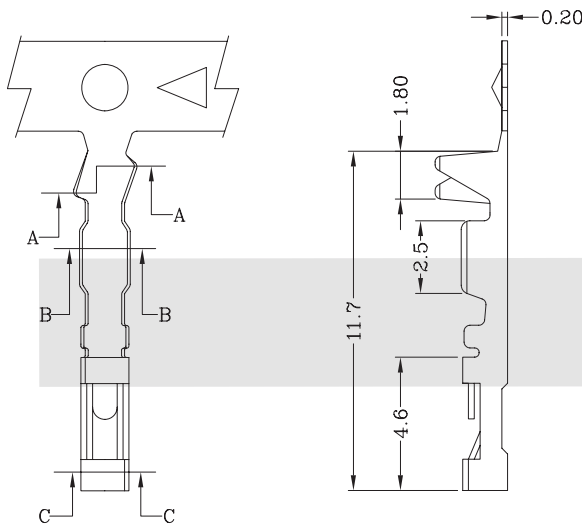

Section A-A

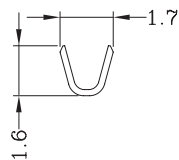

Section B-B

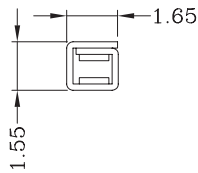

Section C-C

**ORDER INFORMATION**

Product NO.: KLS1-540 A-T

Series No. \_\_\_\_\_ Type: H-Housing T-Terminal  
Pitch: A=2.54mm  
B=2.00mm